

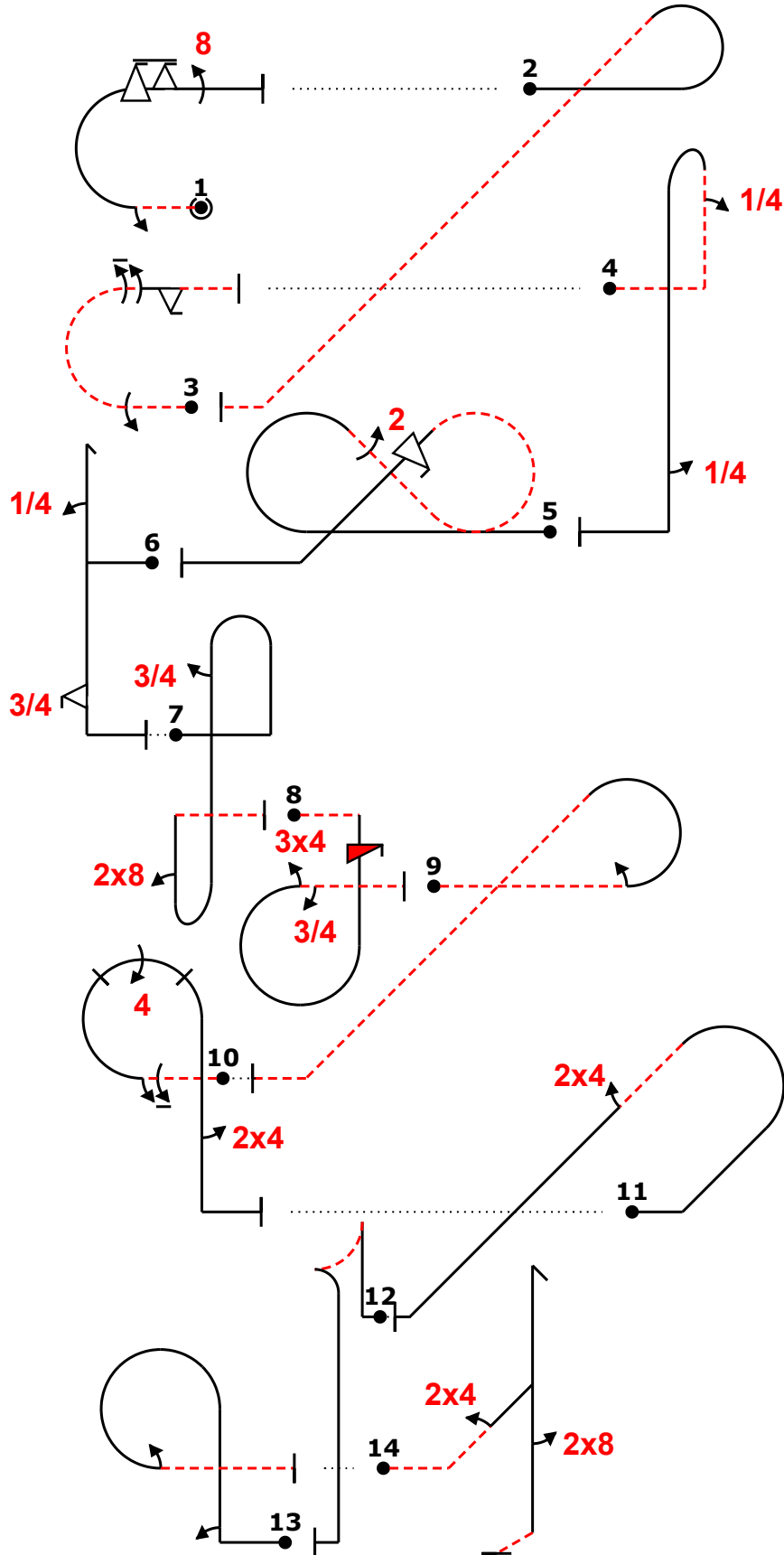

Proposition A - AVA		Form B
Pilot ID	CIVA Advanced Programme4	
		Flight #

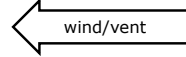

Power			
Fig	Aresti	K	
1 E	7.2.4.2	6	39
	9.1.3.2	4	
	9.9.3.6	14	
	9.8.3.4	15	
2 Add.	8.5.5.1	10	6
3 C	7.2.2.2	9	40
	9.1.3.4	8	
	9.1.3.8	12	
	9.9.3.2	11	
4 Add.	8.4.4.2	14	6
	9.1.1.1	6	
	9.1.5.1	2	
5 D	7.8.1.1	20	40
	9.2.4.4	9	
	9.9.4.4	11	
6 B	5.2.1.1	17	34
	9.1.1.1	6	
	9.9.5.3	11	
7 I	8.8.1.1	18	31
	9.1.5.3	6	
	9.8.1.1	7	
8 G	8.6.1.4	12	33
	9.12.1.4	7	
	9.4.3.3	8	
	9.1.3.3	6	
9 Add.	8.5.7.2	11	6
	9.1.3.2	4	
10 F	8.6.7.2	12	38
	9.1.3.6	10	
	9.4.3.4	11	
	9.4.5.2	5	
11 A	8.4.14.1	12	17
	9.4.4.2	5	
12 J	6.2.2.1	15	15
13 Add.	8.6.2.1	12	6
	9.1.1.2	8	
	9.1.3.2	4	
14 H	5.3.2.2	22	32
	9.4.2.2	7	
	9.8.5.1	3	
<b>Total K = 343</b>			

ed "@E" -2m6f;88 (14,0) "@L" -3% c.....- "@C" -1m9,2f- (21,0) "@L" -,4b....'4 "@D" cc(22)f "@B" 4h...'3f (-2,0) "@I" bb(.....  
 \,3....')8- "@G" -isirp34,3- "@L" -1% -2c.....- (2,0) "@F" .....6p(,44)24. (21,0) "@A" .....+db,24.....+ (3,0) "@J" -2%  
 +ita.....'+" "@L" .....2rp2-- (2,0) "@H" -24dh8.'- eu

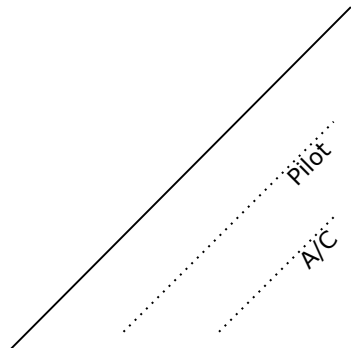

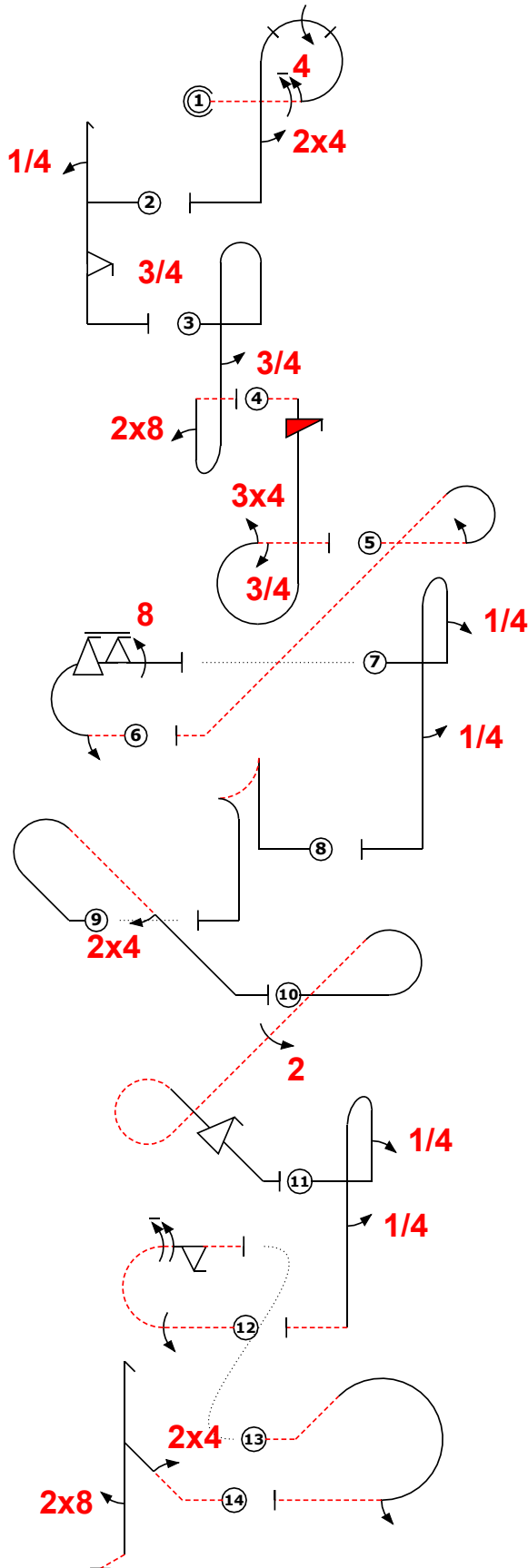

Avion			
Fig	Aresti	K	
1	8.6.7.2	12	38
	9.1.3.6	10	
	9.4.3.4	11	
	9.4.5.2	5	
2	5.2.1.1	17	34
	9.1.1.1	6	
	9.9.5.3	11	
3	8.8.1.1	18	31
	9.1.5.3	6	
	9.8.1.1	7	
4	8.6.1.4	12	33
	9.12.1.4	7	
	9.4.3.3	8	
	9.1.3.3	6	
5	8.5.7.2	11	6
	9.1.3.2	4	
6	7.2.4.2	6	39
	9.1.3.2	4	
	9.9.3.6	14	
	9.8.3.4	15	
7	8.4.1.1	13	6
	9.1.1.1	6	
	9.1.5.1	2	
8	6.2.2.1	15	15
9	8.4.14.1	12	17
	9.4.4.2	5	
10	7.8.1.1	20	40
	9.2.4.4	9	
	9.9.4.4	11	
11	8.4.2.1	14	6
	9.1.1.1	6	
	9.1.5.1	2	
12	7.2.2.2	9	40
	9.1.3.4	8	
	9.1.3.8	12	
	9.9.3.2	11	
13	8.5.3.2	11	6
	9.1.3.2	4	
14	5.3.2.2	22	32
	9.4.2.2	7	
	9.8.5.1	3	
<b>Total K = 343</b>			

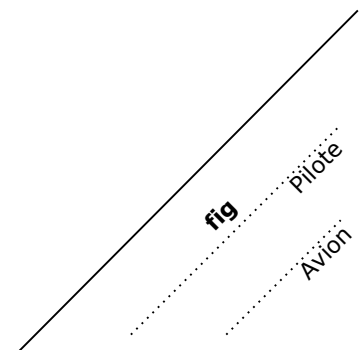

Pilote ID

France Advanced inconnu-libre 3

Vol N°

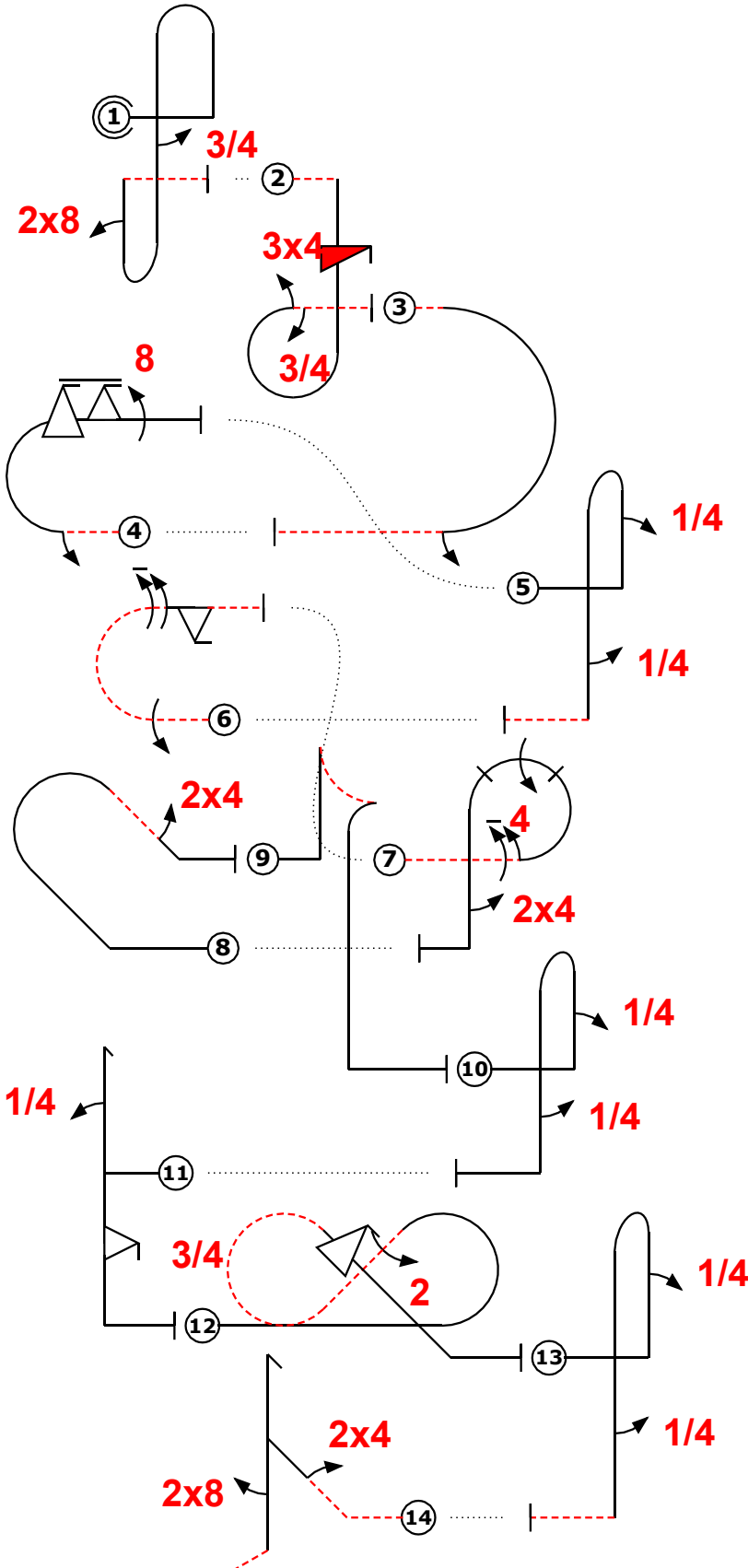

Avion			
Fig	Aresti	K	
1 I	8.8.1.1	18	31
	9.1.5.3	6	
	9.8.1.1	7	
2 G	8.6.1.4	12	33
	9.12.1.4	7	
	9.4.3.3	8	
	9.1.3.3	6	
3 Add.	7.2.2.4	7	6
	9.1.3.2	4	
4 E	7.2.4.2	6	39
	9.1.3.2	4	
	9.9.3.6	14	
	9.8.3.4	15	
5 Add.	8.4.2.1	14	6
	9.1.1.1	6	
	9.1.5.1	2	
6 C	7.2.2.2	9	40
	9.1.3.4	8	
	9.1.3.8	12	
	9.9.3.2	11	
7 F	8.6.7.2	12	38
	9.1.3.6	10	
	9.4.3.4	11	
	9.4.5.2	5	
8 A	8.4.14.1	12	17
	9.4.4.2	5	
9 J	6.2.2.1	15	15
10 Add.	8.4.1.1	13	6
	9.1.1.1	6	
	9.1.5.1	2	
11 B	5.2.1.1	17	34
	9.1.1.1	6	
	9.9.5.3	11	
12 D	7.8.1.1	20	40
	9.2.4.4	9	
	9.9.4.4	11	
13 Add.	8.4.2.1	14	6
	9.1.1.1	6	
	9.1.5.1	2	
14 H	5.3.2.2	22	32
	9.4.2.2	7	
	9.8.5.1	3	
<b>Total K = 343</b>			

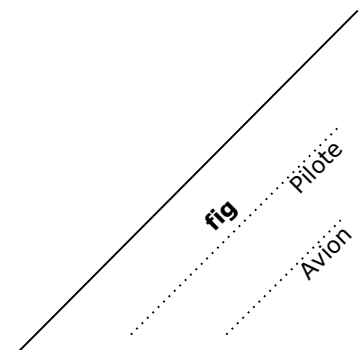

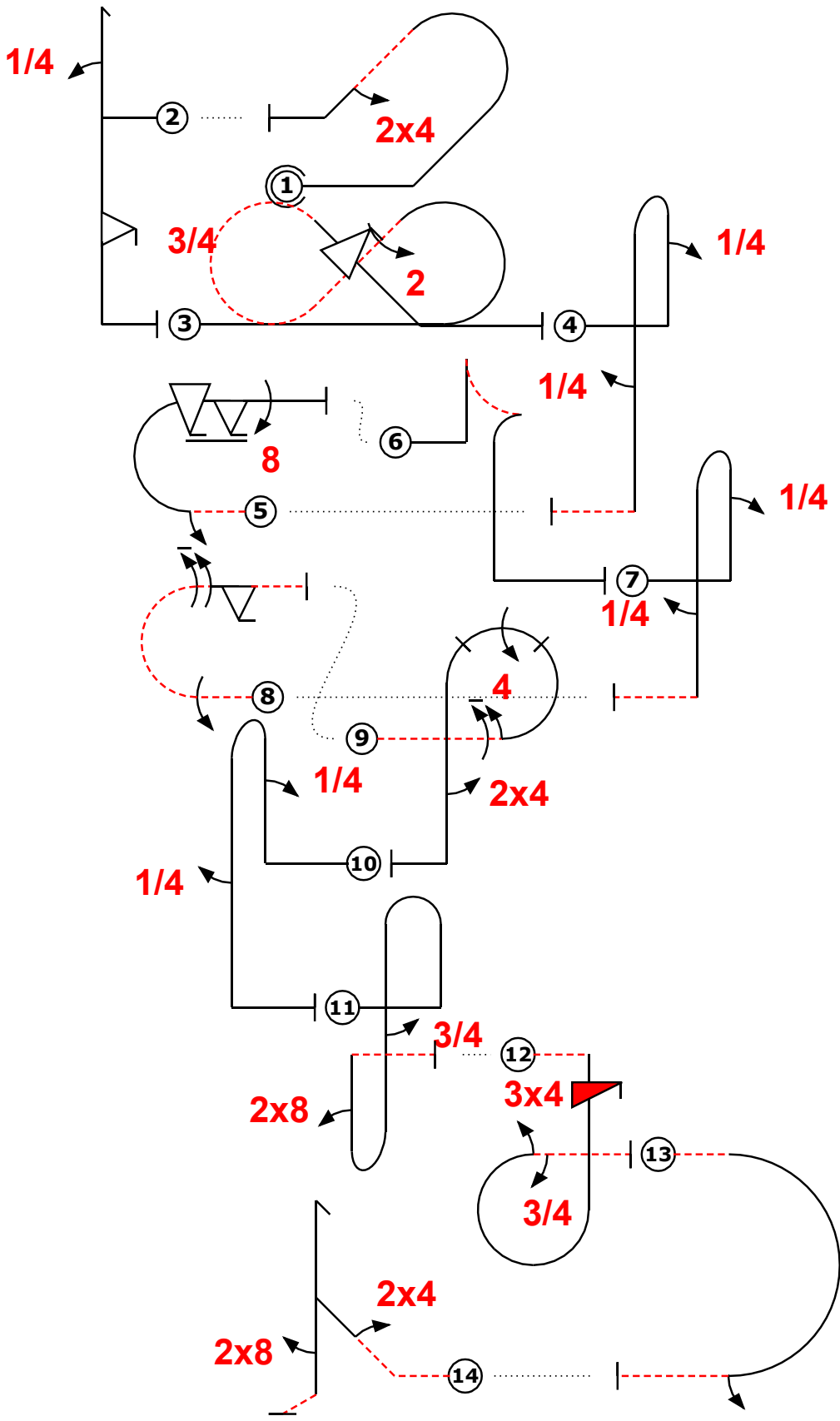

Avion			
Fig	Aresti	K	
1 A	8.4.14.1	12	17
	9.4.4.2	5	
2 B	5.2.1.1	17	34
	9.1.1.1	6	
	9.9.5.3	11	
3 D	7.8.1.1	20	40
	9.2.4.4	9	
	9.9.4.4	11	
4 Add.	8.4.2.1	14	6
	9.1.1.1	6	
	9.1.5.1	2	
5 E	7.2.4.2	6	39
	9.1.3.2	4	
	9.9.3.6	14	
	9.8.3.4	15	
6 J	6.2.2.1	15	15
7 Add.	8.4.2.1	14	6
	9.1.1.1	6	
	9.1.5.1	2	
8 C	7.2.2.2	9	40
	9.1.3.4	8	
	9.1.3.8	12	
	9.9.3.2	11	
9 F	8.6.7.2	12	38
	9.1.3.6	10	
	9.4.3.4	11	
	9.4.5.2	5	
10 Add.	8.4.1.1	13	6
	9.1.1.1	6	
	9.1.5.1	2	
11 I	8.8.1.1	18	31
	9.1.5.3	6	
	9.8.1.1	7	
12 G	8.6.1.4	12	33
	9.12.1.4	7	
	9.4.3.3	8	
	9.1.3.3	6	
13 Add.	7.2.2.4	7	6
	9.1.3.2	4	
14 H	5.3.2.2	22	32
	9.4.2.2	7	
	9.8.5.1	3	
<b>Total K = 343</b>			

fig ..... Pilote  
 ..... Avion